

Delivering leading edge, innovative power solutions for more than **30** years....

Model:GT-C3052-W2U (1-6W)

April 23, 2021

## GT-C3052-W2U (1-6W)

### Information

Model Number	GT-C3052-W2U (1-6W)
Description	GT-C3052-W2U (1-6W), ICT/ITE Power Supply, Wall Plug-in, Regulated Switchmode AC-DC Power Supply AC Adaptor, , Input Rating: 100-240V~, 50-60 Hz, UK BS 1363, 2 Blade w/Dummy Ground Class II, Output Rating: 6 Watts, Power rating with convection cooling (W) , 3-12V in 0.1V increments, Approvals: UKCA; China RoHS; CE; UL 1310; Designed to meet 60335; Designed to meet EN 60601-1; Double Insulation; GOST-R; Level V; RoHS; Ukraine; WEEE;
Model Picture	.
Agency Documents	<a href="http://www.globtek.info/">http://www.globtek.info/</a>
CE EC-Declaration	<a href="https://www.globtek.com/pdf/ec_declaration/a0Oa000000LM7PYEA1">https://www.globtek.com/pdf/ec_declaration/a0Oa000000LM7PYEA1</a>
RoHS/RoHS2 Declaration	<a href="https://www.globtek.com/pdf/rohs_cert/a0Oa000000LM7PYEA1">https://www.globtek.com/pdf/rohs_cert/a0Oa000000LM7PYEA1</a>
REACH Declaration	<a href="https://www.globtek.com/pdf/iso_certificates/REACH.pdf">https://www.globtek.com/pdf/iso_certificates/REACH.pdf</a>
Conflict Minerals Declaration	<a href="https://www.globtek.com/pdf/conflict-minerals.pdf">https://www.globtek.com/pdf/conflict-minerals.pdf</a>

Delivering leading edge, innovative power solutions for more than **30** years....

Model:GT-C3052-W2U (1-6W)

April 23, 2021

**MODEL PARAMETERS**

Type	Wall Plug-in
Technology	Regulated Switchmode AC-DC Power Supply AC Adaptor
Category	ICT/ITE Power Supply
Input Voltage	100-240V~, 50-60 Hz
I/P Amps (A)	0.3A
Wattage (W)	6.0
Vout Range (V)	3-12
Efficiency Level	V
Ingress Protection	
Size (mm)	

Delivering leading edge, innovative power solutions for more than 30 years....

Model:GT-C3052-W2U (1-6W)

April 23, 2021

### ENCLOSURE

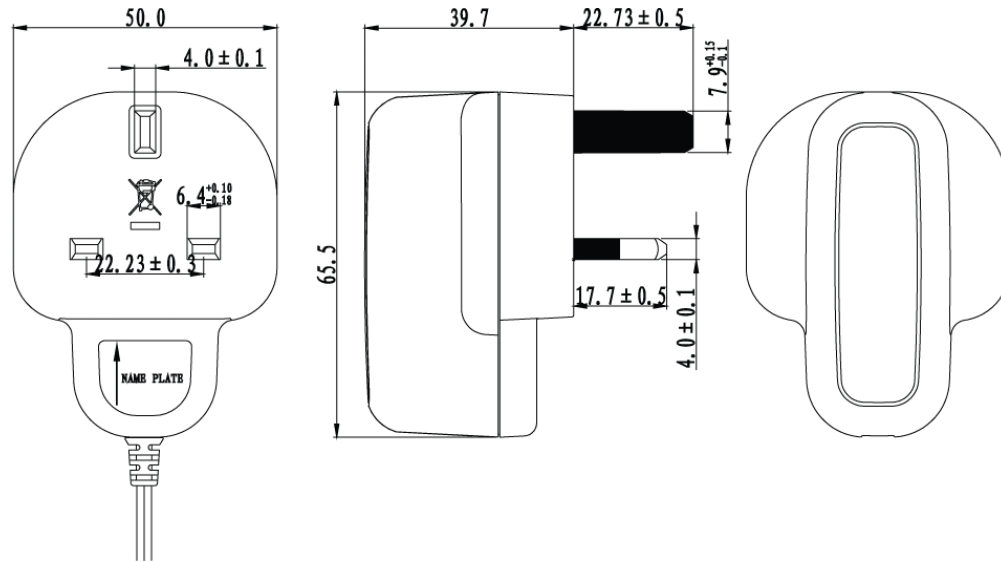

Delivering leading edge, innovative power solutions for more than **30** years....

Model:GT-C3052-W2U (1-6W)

April 23, 2021

## RATING TABLE

Model Number	Voltage	Amps(A)	Watts(W)	RFQ
GT-C3052-0303-W2U	3 V	1.2	3.60	<a href="#">RFQ</a>
GT-C3052-0504-W2U	4 V	1.2	4.80	<a href="#">RFQ</a>
GT-C3052-0605-W2U	5 V	1.2	6.00	<a href="#">RFQ</a>
GT-C3052-0606-W2U	6 V	1	6.00	<a href="#">RFQ</a>
GT-C3052-0607-W2U	7 V	0.9	6.30	<a href="#">RFQ</a>
GT-C3052-0608-W2U	8 V	0.8	6.40	<a href="#">RFQ</a>
GT-C3052-0609-W2U	9 V	0.7	6.30	<a href="#">RFQ</a>
GT-C3052-0610-W2U	10 V	0.6	6.00	<a href="#">RFQ</a>
GT-C3052-0611-W2U	11 V	0.5	5.50	<a href="#">RFQ</a>
GT-C3052-0612-W2U	12 V	0.5	6.00	<a href="#">RFQ</a>

Model:GT-C3052-W2U (1-6W)

April 23, 2021

## SPECIFICATIONS

### A) ELECTRICAL SPECIFICATIONS:

01. Input Voltage: Specified 90-264 Vac, Nameplate rated: 100-240Vac
02. Input Frequency: Specified 47-63 Hz, Nameplate rated 50-60Hz
03. Output Regulation: +/- 5% measured at the output connector
04. Line Voltage Regulation: +/- 1% typical measured at the output connector
- 05 Output Ripple (Vp-p): +/-1% or 300 mV whichever is greater, measured at 20 MHz bandwidth with 0.1 uf ceramic capacitor in parallel with 10 uf electrolytic capacitor connected at the end of the output connector at nominal line
06. Turn-ON/OFF Overshoot: 10% maximum, 1 mS typical recovery time for 25% step load
07. Turn-ON Delay: 2 Second, typical
08. Hold-Up Time: 10 mS typical at nominal input voltage and full load
- 09 Inrush Current: 20A typical at 115VAC input and 20A typical at 230VAC input
10. Switching Frequency: 65 KHz typical

### B) PROTECTION

01. Over-Voltage: Protected Zener clamp across the output
02. Short Circuit: Protected unit will auto recover upon removal of fault
03. Input Protection: Input line fusing

### C) SAFETY

01. Dielectric Withstand Voltage: 4242Vdc from primary to secondary
02. Touch Current: <0.25mA @ 240Vac input voltage

### D) OTHER:

01. MTBF: 200,000 Hours @ 25°C ambient temperature
02. Operating Temperature: 0°C to 40°C ambient temperature
03. Humidity: 0% to 90% relative humidity
04. Storage Temperature: -10°C to 80°C
05. Cooling: Convection
06. ROHS 2: Complies with EU 2011/65/EU and China SJ/T 11363-2006

### E) ENCLOSURE

01. Housing: High impact plastic, 94V0 polycarbonate, non-vented
02. Markings: Label and/or Pad Printed and/or Molded in the case

Delivering leading edge, innovative power solutions for more than **30** years....

Model:GT-C3052-W2U (1-6W)

April 23, 2021

## DERATING CURVE

---

Delivering leading edge, innovative power solutions for more than 30 years....

Model:GT-C3052-W2U (1-6W)

April 23, 2021

**INPUT CONFIGURATION**

 Description UK BS 1363, 2 Blade w/Dummy Ground Class II

The line and neutral pins have a rectangular cross section 6.35 mm by 4.0 mm, 17.7 mm long and with centres 22.2 mm apart. The protective-earth pin is a rectangular cross section 8.0 mm by 4.0 mm, 22.3 mm long and with a centre line 22.2 mm from the line/neutral pin centre line. The dimensions were originally specified in decimal inches with asymmetric tolerances and redefined as minimum and maximum metric dimensions in BS 1363:1984.

Dimensions are chosen to provide safe clearance to live parts. The distance from any part of the line and neutral pins to the periphery of the plug base must be not less than 9.5 mm. This ensures that nothing can be inserted alongside a pin when the plug is in use, and helps keep fingers away from the pins. The minimum insertion distance from the face of the socket-outlet to the first point of contact with a live part is 9.6 mm.

The "Dummy" longer earth pin ensures that the earth path is connected before the live pins, and remains connected after the live pins are removed. The earth pin is too large to be inserted into the line or neutral sockets by mistake.

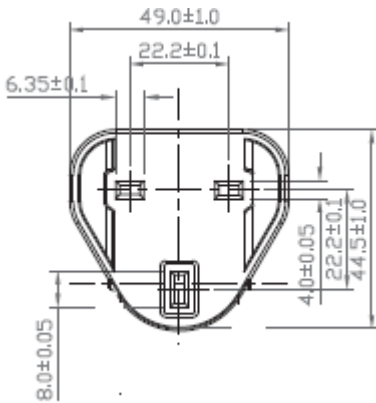

Delivering leading edge, innovative power solutions for more than 30 years....

Model:GT-C3052-W2U (1-6W)

April 23, 2021

**OUTPUT CONFIGURATION**

Common output connector options:

 L Type (Coaxial  
5.5x2.5mm plug)

 C Type (Coaxial  
5.5x2.1mm plug)

 K Type (Coaxial  
3.5x1.3mm plug)

 LL Type (5.5x2.5mm  
Locking 760k type)

 CL Type (5.5x2.1mm  
Locking S761k type)

 ML2 Type (Molex  
housing 43025-0200)

 YL3 Type  
(KPPX-3P)

YL4 Type (KPPX-4P)

 EJ1/2/3/4/5 (EIAJ  
RC-5320A type  
connectors)

 MSB Type (Micro  
USB)

 USBC Type (USB  
Type C)

 Inquire for custom  
design

 For a comprehensive list of options, [click here](#)

Contact GlobTek for your specific requirements or custom solutions.











Delivering leading edge, innovative power solutions for more than **30** years....

Model:GT-C3052-W2U (1-6W)

April 23, 2021



## Approvals

Logo	Description
	CE Certification
	CHINA SJ/T 11364-2014, China RoHS Chart: <a href="http://en.globtek.com/globtek-rohs.php">http://en.globtek.com/globtek-rohs.php</a>
No Logo	Designed to meet cULus LISTED UL 1310 Class 2 up to 36 volts, 5.0 Amps
No logo	Designed to meet EN 60335-1 (Safety of Household and Similar Electrical Appliances, Part 1: General Requirements) up to 36 volts
No Logo	Designed to meet EN 60601-1:2006 + A11:2011 +A1:2013 3rd Edition
	
	GOST-R mark for Russia(Document: <a href="http://www.globtek.com/html/iso_certificates/GT_GOST-R.pdf">http://www.globtek.com/html/iso_certificates/GT_GOST-R.pdf</a> ). 03/15/2015. Due to lack of demand, GlobTek will not be renewing it's GOST certification. Please contact your sales engineer for pricing on EAC.
	Indoor Use Only - Mark is on the label or Molded in the case
<b>EFFICIENCY LEVEL</b> 	Efficiency: complies to section 301 of Energy Independence and Security Act (EISA) complies with Energy Star tier 2 (North America), ECP tier 2 (China), MEPS tier 2 (Australia), Code of Conduct (Europe)
RoHS	Specifications of directive 2011/65/EU Annex VI (ROHS-2) with amendment 2015/863-EU (ROHS-3) <a href="http://www.ce-mark.com/Rohs%20final.pdf">http://www.ce-mark.com/Rohs%20final.pdf</a>
	UKCA Certification
	UKCA Certification

Delivering leading edge, innovative power solutions for more than **30** years....

Model:GT-C3052-W2U (1-6W)

April 23, 2021

 10276	Ukraine UKRSepto (Document: <a href="http://www.globtek.com/html/iso_certificates/GT_Ukraine.pdf">www.globtek.com/html/iso_certificates/GT_Ukraine.pdf</a> )
	WEEE: Complies with EU 2012/19/EU ( <a href="http://ec.europa.eu/environment/waste/weee/index_en.htm">http://ec.europa.eu/environment/waste/weee/index_en.htm</a> ) Mark is on the label or Molded in the case