

Delivering leading edge, innovative power solutions for more than 30 years....

Model:GT-86182-WWVV-WF2A-USB

December 3, 2021

GT-86182-WWVV-WF2A-USB

Information

Model Number	GT-86182-WWVV-WF2A-USB
Description	Quick Charge 2.0 & 3.0 BC1.2, APPLE 2.4A., SAMSUNG 2.0A, FCP, SFCP, AFC

Model Picture



Agency Documents	http://www.globtek.info/certs/GT-86182-W(F)2-USB/
CE EC-Declaration	https://www.globtek.com/pdf/ec_declaration/a003a00000Lx1k7EAB
RoHS/RoHS2 Declaration	https://www.globtek.com/pdf/rohs_cert/a003a00000Lx1k7EAB
REACH Declaration	https://www.globtek.com/pdf/iso_certificates/REACH.pdf
Conflict Minerals Declaration	https://www.globtek.com/pdf/conflict-minerals.pdf

Delivering leading edge, innovative power solutions for more than **30** years....

Model:GT-86182-WWVV-WF2A-USB

December 3, 2021

MODEL PARAMETERS

Type	Wall Plug-in
Technology	USB Adaptive Power Supply AC Adaptor
Category	ICT/ITE Power Supply
Input Voltage	100-240V~, 50/60Hz
I/P Amps (A)	0.6 A
Wattage (W)	18.0
Vout Range (V)	5/9/12V_QC3.0, BC1.2, APPLE 2.4A., SAMSUNG 2.0A, FCP, SFCP, AFC
Efficiency Level	USA DOE Level VI / Eco-design Directive 2009/125/EC, (EU) 2019/1782
Ingress Protection	Indoor Use
Size (mm)	76 (L) * 40 (W) *28.9(H)

PROPRIETARY INFORMATION

PROPRIETARY OF GLOBTEK, INC. ANY REPRODUCTION, DISCLOSURE OR USE OF THIS DRAWING, IN WHOLE OR IN PART, IS HEREBY PROHIBITED EXCEPT AS SPECIFIED IN WRITING BY GLOBTEK, INC.

<https://www.globtek.com/datasheet/w70588>

Delivering leading edge, innovative power solutions for more than 30 years....

Model:GT-86182-WWVV-WF2A-USB

December 3, 2021

ENCLOSURE

Case: Black

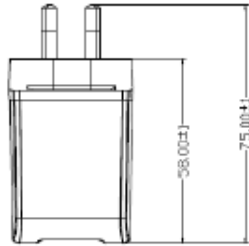
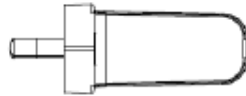
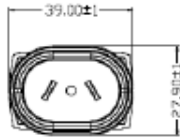
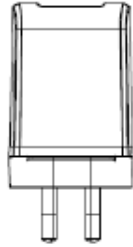

Delivering leading edge, innovative power solutions for more than **30** years....

Model:GT-86182-WWVV-WF2A-USB

December 3, 2021

RATING TABLE

Model Number	Voltage	Amps(A)	Watts(W)	RFQ
GT-86182-1812-WF2A-USB	5,9,12 V	1.5	18.00	RFQ

SPECIFICATIONS

A) ELECTRICAL SPECIFICATIONS:

01. Input Voltage: Specified 90-264 Vac, Nameplate rated: 100-240Vac
02. Input Frequency: Specified 47-63 Hz, Nameplate rated 50-60Hz
03. Inrush Current: at full load, 25° C, cold start
04. Efficiency: Compliant with Efficiency Level VI and ErP European Commission's Ecodesign Directive (2005/32/EC) / CoC Tier 2 Compliant
05. No Load Standby Power: <math><0.075W @ 230Vac</math>
06. Line regulation: $\pm 2\%$ At nominal input voltage and full load
07. Total output regulation: $\pm 5\%$
08. Output Voltage: Tolerance $\pm 5\%$
09. Turn On Delay: 3 Seconds maximum at nominal input Voltage
10. Hold Up Time: 5ms min at nominal Input Voltage
11. Ripple Voltage: 200 mVp-p At 20 MHz, and output parallel with 0.1uF & 10uF capacitors to ground Temperature at 25°C, and nominal input voltage
12. Compliant with CLASS A Qualcomm Quick Charge 3.0 and Quick Charge 2.0. 3.6V~12V DC with 18 watts maximum output. Also compliant with BC1.2, APPLE 2.4A., SAMSUNG 2.0A, FCP, SFCP, AFC

Quick Charger 3.0 protocol

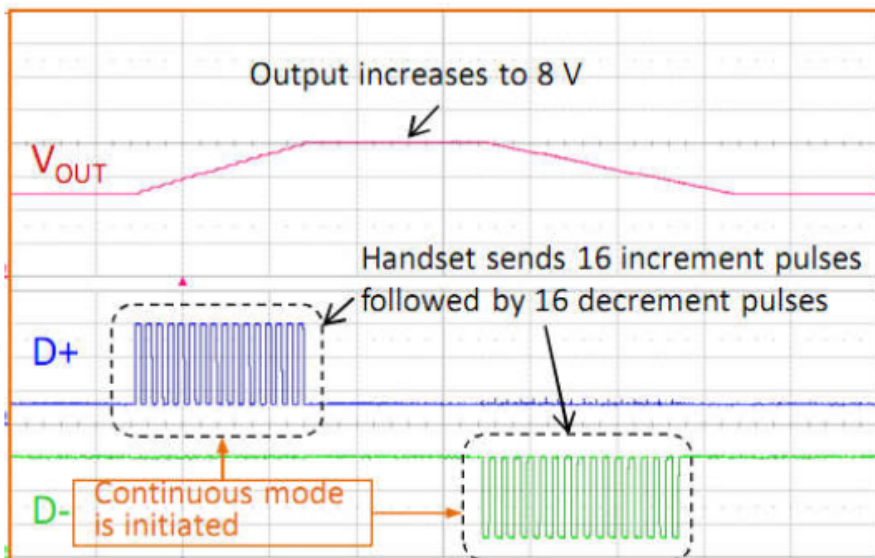

B) PROTECTION

01. Over voltage protection: Output shut down and auto restart
02. Short circuit protection: The adapter shall not be damaged by short the DC output to Ground
03. Over Load Protection: Output shut down and auto restart

C) SAFETY

01. HI-POT : Input to output : 3000VAC or 4242VDC 10mA 1 minute

Delivering leading edge, innovative power solutions for more than 30 years....

Model:GT-86182-WWVV-WF2A-USB

December 3, 2021

- 02. Leakage current: 0.25mA maximum, at nominal AC input voltage and frequency
- 03. ESD: 8KV(air) / 4KV (contact)

D) EMC

- 01. Emissions, per EN 55032, EN 61000-6-3, EN 61000-6-4
 - Conducted Emissions: Class B, FCC Part 15, Class B
 - Radiated Emissions: Class B, FCC Part 15, Class B
- 02. Line Frequency Harmonics EN61000-3-2, Class A
- 03. Voltage Fluctuations/Flicker EN61000-3-3
- 04. Immunity, per EN 55024, EN 61000-6-1, EN 61000-6-2
 - Static Discharge Immunity EN61000-4-2, 4kV Contact Discharge, 8kV air discharge
 - Radiated RF Immunity EN61000-4-3, 3V/m 80-1000MHz, 80% 1KHz AM.
 - EFT/Burst Immunity EN61000-4-4, 1kV/100kHz.
 - Line Surge Immunity EN61000-4-5, 1kV differential, 2kV common-mode
 - Conducted RF Immunity EN61000-4-6, 3Vrms, 80% 1KHz AM
 - Power Frequency Magnetic Field Immunity EN61000-4-8, 1A/m
 - Voltage Dip Immunity EN61000-4-11, Criteria

E) OTHER:

- 01. MTBF: 200,000 Hours @ 25°C ambient temperature
- 02. Operating Temperature: 0°C to 40°C ambient temperature
- 03. Humidity Operating : 20% to 85%
- 04. Storage Temperature: -20°C to 60°C
- 05. RoHS 2: Complies with EU 2011/65/EU and China GB/T26572-2011

F) ENCLOSURE

- 01. Housing: High impact plastic, 94V0 polycarbonate, non-vented
- 02. Size: 38.7 (L) * 23.7 (W) * 51.5(H) mm maximum
- 03. Weight : 48.0 g
- 04. Markings: Label and/or Pad Printed and/or Molded in the case

Delivering leading edge, innovative power solutions for more than 30 years....

Model:GT-86182-WWVV-WF2A-USB

December 3, 2021

DERATING CURVE

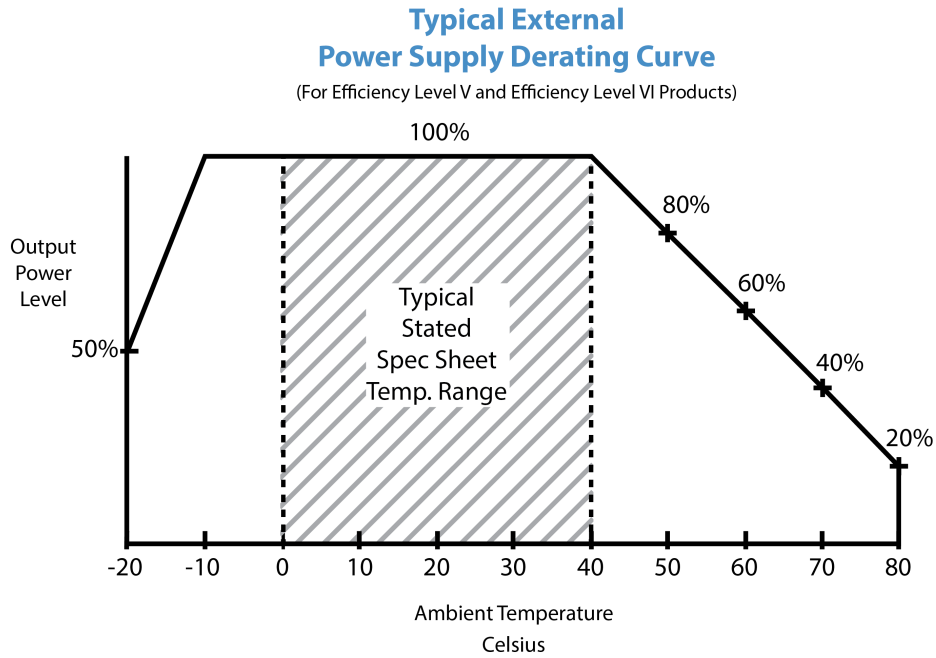

Delivering leading edge, innovative power solutions for more than 30 years....

Model:GT-86182-WWVV-WF2A-USB

December 3, 2021

INPUT CONFIGURATION

Description Australian AS 3112 configuration: SAA 2 pins Class II

Used in [Australia](#), [New Zealand](#), [Fiji](#), [Papua New Guinea](#) and [Tokelau](#), has two flat pins forming an inverted V-shape. These flat blades measure 6.3 by 1.5 mm with the Active and Neutral pins of 17 mm in length set 30° to the vertical on a nominal pitch of 13.7 mm. A standard power outlet in Australia provides a nominal voltage of 230 volts at a maximum of 10 amps and always includes an earth connection. As in the UK, its outlets are individually switched for extra safety. [Argentina](#) uses a similar plug, with pins 1 mm longer.

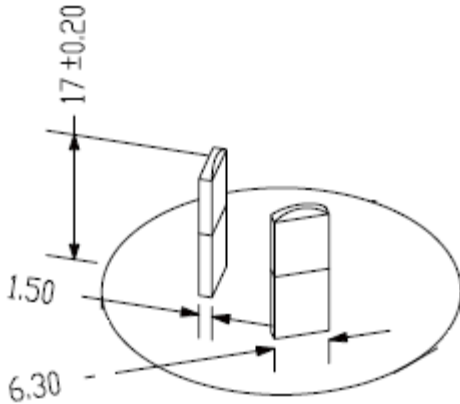

Delivering leading edge, innovative power solutions for more than 30 years....

Model:GT-86182-WWVV-WF2A-USB

December 3, 2021

OUTPUT CONFIGURATION

Common output connector options:

 L Type (Coaxial
5.5x2.5mm plug)

 C Type (Coaxial
5.5x2.1mm plug)

 K Type (Coaxial
3.5x1.3mm plug)

 LL Type (5.5x2.5mm
Locking 760k type)

 CL Type (5.5x2.1mm
Locking S761k type)

 ML2 Type (Molex
housing 43025-0200)

 YL3 Type
(KPPX-3P)

YL4 Type (KPPX-4P)

 EJ1/2/3/4/5 (EIAJ
RC-5320A type
connectors)

 MSB Type (Micro
USB)

 USBC Type (USB
Type C)

 Inquire for custom
design

 For a comprehensive list of options, [click here](#)







Contact GlobTek for your specific requirements or custom solutions.

Delivering leading edge, innovative power solutions for more than **30** years....

Model:GT-86182-WWVV-WF2A-USB

December 3, 2021

Approvals

Logo	Description
	CHINA SJ/T 11364-2014, China RoHS Chart: http://en.globtek.com/globtek-rohs.php
	
	Declaration ДС № EAЭC N RU Д-US.KA01.B.10453_19 Custom Union of Russia, Belarus and Kazakhstan http://www.globtek.com/redirect/?loc=gost-certificate-eac-declaration
	Indoor Use Only - Mark is on the label or Molded in the case
LPS	Limited Power Source 60950
RoHS	Specifications of directive 2011/65/EU Annex VI (ROHS-2) with amendment 2015/863-EU (ROHS-3) http://www.ce-mark.com/Rohs%20final.pdf
 10276	Ukraine UKRSePro (Document: www.globtek.com/html/iso_certificates/GT_Ukraine.pdf)
	WEEE: Complies with EU 2012/19/EU (http://ec.europa.eu/environment/waste/wEEE/index_en.htm) Mark is on the label or Molded in the case